



TM Series
Panel Mount Type
LCD Touchscreen Monitor
Model "G"
Model "H"
Product Specification

10.4"	TMG-310-DC00-01 TMH-310-DC00-01
12.1"	TMG-312-DC00-01 TMH-312-DC00-01

Table of Contents

1. Summary	2
2. Model	2
3. Items Included in Package.....	2
4. Specifications	3
4-1 Function Specification.....	3
4-2 Touchpanel Specification.....	3
4-2-1 Projective Capacitive Method.....	3
4-2-2 Analog Resistive Method.....	4
4-3 General Specification	4
4-4 Environmental Specification.....	5
4-5 Installation Specification.....	5
4-6 Name of Each Parts and Their Functions.....	6
4-6-1 TMG-310-DC00-01, TMH-310-DC00-01.....	6
4-6-2 TMG-312-DC00-01, TMH-312-DC00-01.....	7
5. Interface Connectors (Ports).....	9
5-1 DVI (Digital Video Input).....	9
5-2 Analog RGB (Analog Video Input).....	9
5-3 Touchscreen Interface (USB).....	9
5-4 Power Connector	9
6. Main Functions	10
6-1 Multi-Scanning	10
6-2 OSD Function	10
6-3 Support Signal Timing	10
7. Installation	11
7-1 Mounting Conditions	11
7-2 How to Mount	12
7-2-1 Installing to Panels	12
7-2-2 Attaching to “VESA” Standard Arms.....	13
8. Product Certifications	14
8-1 Agency Approvals	14
8-2 Government Regulations.....	14
8-3 EMC Installation and Operation.....	15
9. Product Labels	16
9-1 TMG-310-DC00-01	16
9-2 TMH-310-DC00-01	16
9-3 TMG-312-DC00-01	16
9-4 TMH-312-DC00-01	16
10. FCC Label	16
11. Warranty	17
11-1 Warranty Period	17
11-2 Warranty Exceptions	17
12. Production Discontinuance.....	17
13. Others	18

1. Summary

This document describes the specifications of 10.4" and 12.1" touchscreen monitors of the TM series model "H" and "G".

These products will be referred to as "TM" hereinafter.

2. Model

Model	Specification	
	LCD size	Touch method
TMG-310-DC00-01	10.4"	Projected capacitive type
TMH-310-DC00-01		Analog resistive type
TMG-312-DC00-01	12.1"	Projected capacitive type
TMH-312-DC00-01		Analog resistive type

3. Items Included in Package

The following items are included in the package:

- TM 1unit
- Mounting Brackets 1set (4pcs)
- Waterproof Gasket 1pc (preinstalled to unit)
- Power Connector 1pc

*Caution

The unit is shipped with the protection sheet already installed to the front side display.

Be sure to take the sheet off before installing.

The protection sheet may cause a drop in quality of the surface of the touchscreen depending on the storing environment of the product.

Please be sure to remove the protection sheet within 6 month after shipment.

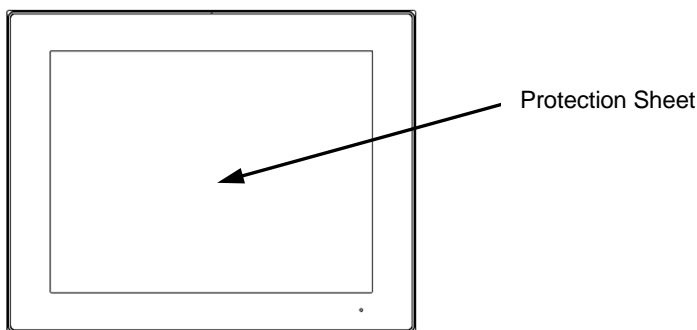

4. Specifications

4-1 Function Specification

Items		Specifications				
		10.4"		12.1"		
		TMG-310-DC00-01	TMH-310-DC00-01	TMG-312-DC00-01	TMH-312-DC00-01	
LCD Panel	Method	TFT Active Matrix Method				
	Resolution	800(W)x600(H) pixels SVGA		800(W)x600(H) pixels SVGA		
	Display Area	211.2mm(W)x158.4mm(H)		246mm(W)x184.5mm(H)		
	Pixel Pitch	0.088mm(W)x0.264mm(H)		0.103mm(W)x0.308mm(H)		
	Color	App. 16.77M colors		App. 16.77M colors		
	View Angle (Typ.)	Vertical	140°(80°/60°)		160°(80°/80°)	
		Horizontal	160°(80°/80°)		160°(80°/80°)	
		Direction	From 6 o'clock direction (Gray Inversion)			
	Brightness (Typ.)	400 cd/m ²	320 cd/m ²	450 cd/m ²	360 cd/m ²	
	Backlight	LED				
Backlight Life (Typ.)	70,000 hours average ^{※1}					
Input Signal	Analog	SYNC	Separate, TTL, +/- polarity			
		RGB	Analog, positive polarity (0-0.7Vp-p 75Ω)			
	Digital	DVI 1.0 Compliant				
	Horizontal Scanning	30KHz to 80KHz				
	Vertical Scanning	50Hz to 75Hz				

※1 Time until brightness declines 50% from the initial value at maximum brightness (at ambient temperature of 25°C).

4-2 Touchpanel Specification

4-2-1 Projective Capacitive Method

Item	Specification	
	10.4"	12.1"
	TMG-310-DC00-01	TMG-312-DC00-01
Type	Projective Capacitive	
Input Method	Finger	
Maximum Simultaneous Input	Two points	
Operating Life	Continuous Typing (finger input) : 50 million times	
Communication Method	USB 2.0	
Complying OS ^{※1}	Microsoft® Windows® 7 (32bit/64bit) Microsoft® Windows® 8/8.1 (32bit/64bit) ^{※2} Microsoft® Windows® 10 (32bit/64bit)	

※1 Windows Standard can be used with touchscreen driver. (Windows 7/8/8.1/10)

※2 Two point touch and gesture operations have been verified.

4-2-2 Analog Resistive Method

Item	Specification	
	10.4"	12.1"
	TMH-310-DC00-01	TMH-312-DC00-01
Type	Analog Resistive	
Input Method	Finger or R0.8 Polyacetal pen	
Multi-touch capacity	One point	
Operating Live	Keystroke (Finger input) : 10million times Character Input (input by pen) : 100thousnd characters	
Communication Method	USB 2.0	
Complying OS※ ¹	Microsoft® Windows® 7 (64bit) Microsoft® Windows® 8/8.1 (64bit) ※ ² Microsoft® Windows® 10 (64bit) ※ ²	

※1 Dedicated driver installation needed.

※2 Please contact us for operation confirmation of Windows®8/8.1/10.

4-3 General Specification

Item	Specification			
	10.4"		12.1"	
	TMG-310-DC00-01	TMH-310-DC00-01	TMG-312-DC00-01	TMH-312-DC00-01
Absolute Maximum Rate	30V DC			
Rated Voltage	12V DC / 24V DC			
Permissible Voltage Range	12V±20% / 24V±20%			
Power Consumption	MAX 10W			
USB Consumption Current*	5V DC 50mA (Max)			

*Shows power consumption of touchscreen and touchscreen controller.

*Not necessary to change 12V/24V DC.

4-4 Environmental Specification

Item	Specification			
	10.4"		12.1"	
	TMG-310-DC00-01	TMH-310-DC00-01	TMG-312-DC00-01	TMH-312-DC00-01
Ambient Operating Temperature (Inside cabinet and Display side)	0°C to 50°C			
Ambient Storage Temperature	-10°C to +60°C			
Ambient Operating Humidity	10%RH to 85%RH (Non-condensing, Wet bulb temperature is 39°C or less)			
Ambient Storage Humidity	10%RH to 85%RH (Non-condensing, Wet bulb temperature is 39°C or less)			
Dust	Prohibited			
Environment	Pollution Degree 2, Indoor use			
Altitude Resistance	800hPa to 1114hPa (Altitude of 2000m or less)			
Vibration Resistance	5Hz to 9Hz Single amplitude: 3.5mm 9Hz to 150Hz Constant Accelerated Velocity 9.8m/s ² X,Y,Z each directions, 10 times (100 minutes) IEC61131-2(JIS B 3502) compliant			
RoHS	Compliant with EU RoHS Directive (2011/65/EU)			

4-5 Installation Specification

Item	Specification			
	10.4"		12.1"	
	TMG-310-DC00-01	TMH-310-DC00-01	TMG-312-DC00-01	TMH-312-DC00-01
Grounding	Grounding resistance of 100Ω, 2mm ² [0.0062inch ²] or thicker wire, or your country's applicable standard.			
Structure	Protection Structure : IP65 ^{※1} (Only front display side at panel mount)			
Cooling Method	Natural Convection			
External Dimension	278(W) x 222(H) x 56(D)mm		314(W) x 248(H) x 56(D)mm	
Weight	App 2400g	App 2200g	App 2900g	App 2600g
Panel cut-out dimension	266 _{+0.5/-0} (W) x 210 _{+0.5/-0} (H)mm		302 _{+0.5/-0} (W) x 236 _{+0.5/-0} (H)mm	

※1 Protection structure of front area when mounted to panel. The degree of protection provided has been confirmed, however their performance cannot be guaranteed for every environment. Especially for oils, if unit is prolonged to vaporized oil or cutting fluids with low viscosity, oil might enter from area where touchscreen has lifted, thus may need special measurements. Please check the installation environment prior to use. Also, gaskets that have been used for a long time or have once been applied to panels, original level of protection cannot be guaranteed due to possible damage or dirt. To maintain the original level of protection, be sure to replace the gasket regularly.

4-6 Name of Each Parts and Their Functions

4-6-1 TMG-310-DC00-01, TMH-310-DC00-01

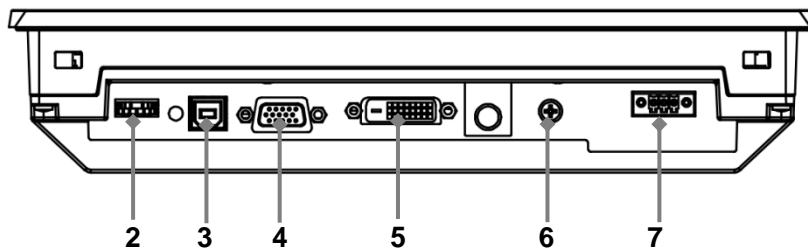
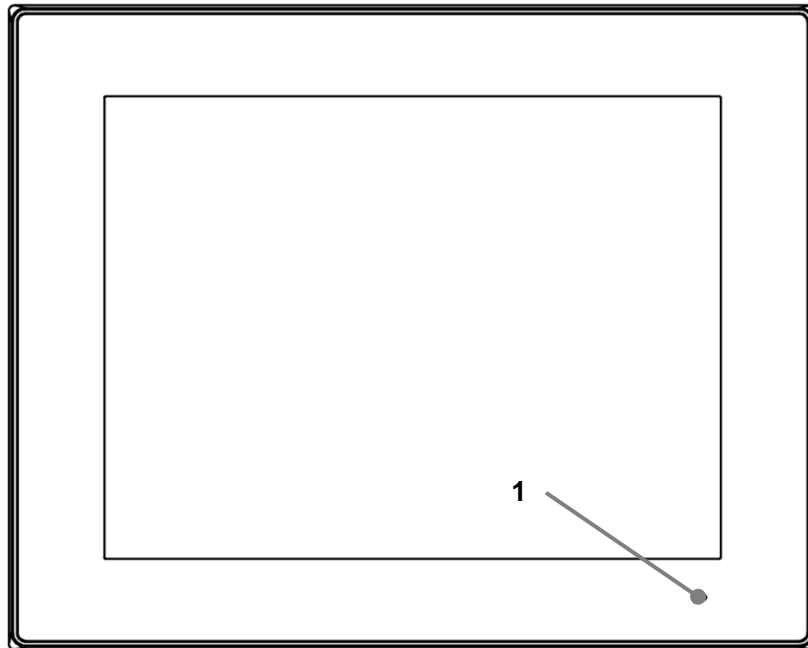

4-6-2 TMG-312-DC00-01, TMH-312-DC00-01

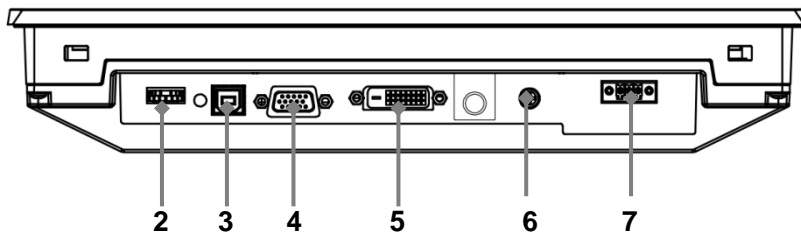
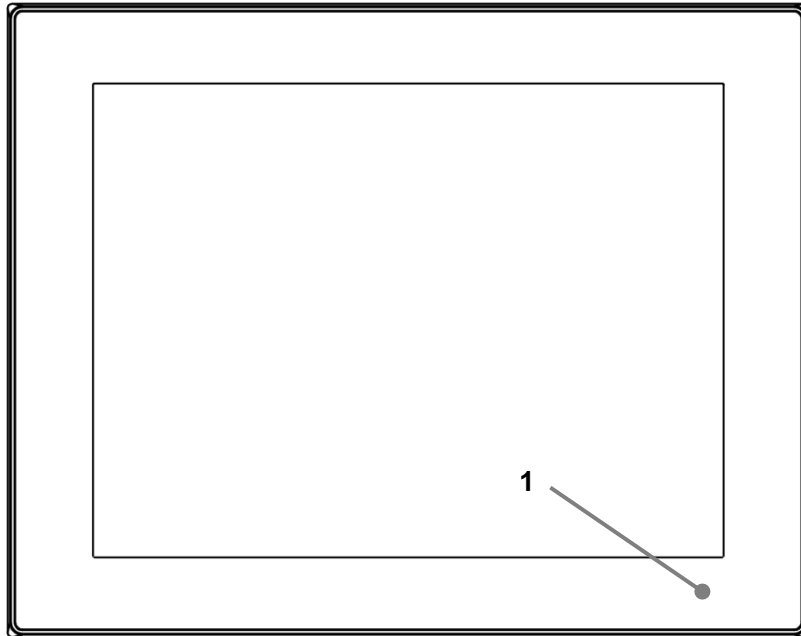

No	Name	Function
1	Status LED	Displays power of monitor and video input signal status Green: Power ON with input signal Red: Power ON without input signal Unlit: Power OFF
2	Dial Switch	Power ON/OFF OSD (On Screen Display) operation
3	Touchscreen Interface	USB Type-B Connector
4	Video Input (Analog)	D-SUB 15Pin (Mini) Connector
5	Video Input (Digital)	DVI Connector
6	FG Terminal (Function Earth Terminal)	Terminal used for FG when connection between FG and touchscreen cannot be made via power input.
7	Power Input	Input power (12/24V DC)

*Connects the touchscreen monitor and FG by FG terminal or power input.

Coordinates input by touchscreen of model "G" may not be stable according to its installation condition.

*Dial Switch Operations

① Power ON/OFF

- Push dial switch to turn the monitor ON.
 - Push and hold for more than 2 seconds to turn the monitor OFF.
- *Leave an interval of 5 seconds when repeatedly turning the power ON and OFF

② OSD Operation

- Push the dial switch when the touchscreen is ON to display the OSD
- Turn the switch clock-wise or counter-clock-wise to move the selected item or to adjust value.
- Push the dial switch to set the adjusted value or to decide on the item selected.

5. Interface Connectors (Ports)

5-1 DVI (Digital Video Input)

Interface: DVI 1.0

Connector: DVI-I Female (Port specification is DVI-D)

Pin No	Signal	Pin No	Signal	Pin No	Signal
1	DATA2-	11	GND	21	NC
2	DATA2+	12	NC	22	GND
3	GND	13	NC	23	CLKa+
4	NC	14	DDC 5V	24	CLKa-
5	NC	15	GND	25	NC
6	DVI_DDC_SCL	16	GND	26	NC
7	DVI_DDC_SDA	17	DATA0-	27	NC
8	NC	18	DATA0+	28	NC
9	DATA1-	19	GND	29	GND
10	DATA1+	20	NC	-	-

5-2 Analog RGB (Analog Video Input)

Connector: D-SUB15 Pin (mini) Female

Pin No	Signal	Pin No	Signal	Pin No	Signal
1	RED IN	6	R-GND	11	GND
2	GREEN IN	7	G-GND	12	SDA DDC
3	BLUE IN	8	B-GND	13	SYNC. H
4	GND	9	PC 5V	14	SYNC. V
5	GND	10	DET	15	SCL DDC

5-3 Touchscreen Interface (USB)

Interface: USB 2.0

Connector: USB type B

5-4 Power Connector

Connector :284539-3(Tyco Electronics)

Compliant Connector: 284510-3(Tyco Electronics)

Pin No.	Signal
1	FG※
2	-(GND)
3	+(12V/24V)

※FG is connected to the M4 terminal next to the power connector.

Please connect either one to FG.

6. Main Functions

6-1 Multi-Scanning

Automatically enlarges or shrinks images to match the input and LCD display resolution.

However, because it will be processed according to the resolutions, there are possibilities of deformation of images and/or blurring of characters.

6-2 OSD Function

Input and output image adjustment can be done with the OSD (On Screen Display).

Setting will be memorized even after power is turned off and will not change unless done so intentionally.

Items that can be adjusted with the OSD are as listed below.

Items that can be adjusted with the OSD

Main Menu	Sub Menu	Function
Picture	Contrast	For adjusting the contrast
	Brightness	For adjusting the LCD brightness
	Sharpness	For adjusting the sharpness (smoothing)
Display (Valid only with Analog video input)	Auto Adjust	For automatically optimizing the display
	Phase	For adjusting the flickering/blurring
	H.Position	For adjusting the horizontal position of screen
	V.Position	For adjusting the vertical position of screen
Color	Pixel Clock	For adjusting the frequency (clock)
	Gamma	For adjusting the gamma value of screen
	Color temp	For adjusting the color temperature of screen
	Color Effect	For adjusting image quality

6-3 Support Signal Timing

No	Resolution	H-Freq. (KHz)	V-Freq. (Hz)
1	640×480	31.47	59.94
2	640×480	37.86	72.81
3	640×480	37.50	75.00
4	720×400	31.47	70.09
5	800×600	35.16	56.25
6	800×600	37.88	60.32
7	800×600	48.08	72.19
8	800×600	46.88	75.00

7. Installation

7-1 Mounting Conditions

When installing to panels, be sure to have enough space for connecting and disconnecting of cables and mounting brackets.

-Consider specification temperature between TM and the structure and parts, and be sure to have good ventilation.

-Please use in an environment where ambient temperature and humidity during use is within their designated ranges.

(Ambient temperature is for both inside the cabinet and panel face.)

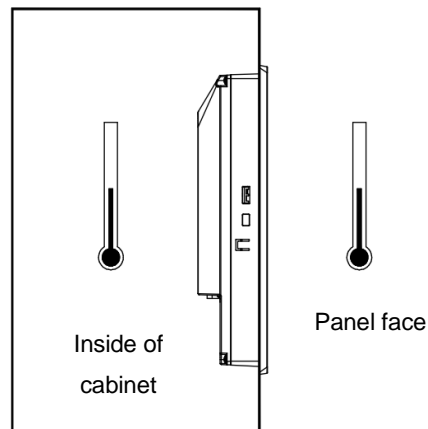

- TM should not be mounted at an angle more than 30° as illustrated in the following figure.

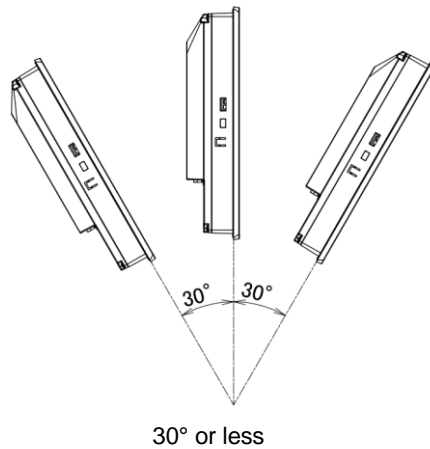

- When mounting the TM at an angle of more than 30 degrees or more, please use forced air cooling to ensure the temperature specification.

7-2 How to Mount

7-2-1 Installing to Panels

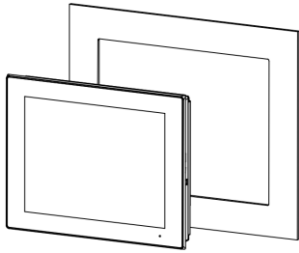

Panel thickness shall be 1.6mm to 5.0mm

Panel cut-out dimension is as shown in below diagram.

Panel Opening Dimensions

10.4" TMG-310-DC00-01/TMH-310-DC00-01	12.1" TMG-312-DC00-01/TMH-312-DC00-01
<p>Diagram showing the panel opening dimensions for the 10.4" model. The width is $266^{+0.5}_{-0}$ and the height is $210^{+0.5}_{-0}$. The opening is labeled "Under 4-R3".</p>	<p>Diagram showing the panel opening dimensions for the 12.1" model. The width is $302^{+0.5}_{-0}$ and the height is $236^{+0.5}_{-0}$. The opening is labeled "Under 4-R3".</p>

7-2-2 Attaching to “VESA” Standard Arms

TM can be installed on a commercially available Video Electronics Standards Association (VESA) MIS-D arm, stand, or apparatus that is listed to comply with the UL1678 standard.

Please refer to each arm or stand manual for attaching directions.

Dimensions of the installation holes are as shown in below diagram.

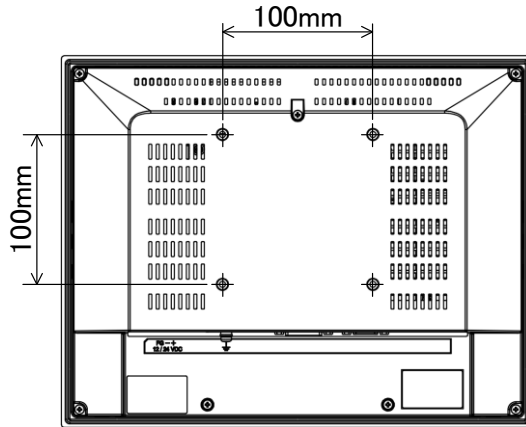

Use M4 screw at torque range of 0.7Nm to 0.8Nm when attaching.

Select M4 screws so it is 8mm or less in depth from the rear side of the TM case.



8. Product Certifications

8-1 Agency Approvals

TM is intended for use in industrial environments and, when properly installed, shall comply with the following agency approvals.

Note:

The agency approvals listed in the following table and on the Declaration of Conformities are believed to be accurate; however, the product's agency approvals should be verified by the marking on the unit itself.

Description	Agency Marking	Comments
N.A. Safety for Programmable Controller		Certification by Underwriter's Laboratories (UL) to UL 61010-1; UL 61010-2-201; CSA C22.2 No 61010-1-12, No 61010-2-201
Electromagnetic Compatibility Directive European Electromagnetic Compatibility (EMC) for Industrial Control Equipment		Self-declaration in accordance with European Directives EN61000-6-2, EN61000-6-4 (Model"G" only)

8-2 Government Regulations

The FCC requires the following note to be published according to FCC guidelines is intended for use in industrial environments and, when properly installed, shall comply with the following agency approvals.

Note:

This equipment has been tested and found to comply with the limits for a Class A digital device, pursuant to Part 15 of the FCC Rules. These limits are designed to provide reasonable protection against harmful interference when the equipment is operated in a commercial environment. This equipment generates, uses, and can radiate radio frequency energy and, if not installed and used in accordance with the instruction manual, may cause harmful interference to radio communications. Operation of this equipment in a residential area is likely to cause harmful interference in which case the user is required to correct the interference at their own expense.

Changes or modifications to this unit that are not expressly approved by Seedsware could void the user's authority to operate the equipment.

Industry Canada requires the following note to be published:

Note: This Class A digital apparatus complies with Canadian CAN ICES-3 (A)/NMB-3 (A).

8-3 EMC Installation and Operation

Considerations

This equipment has been tested and found to comply with a minimum level of EMC performance as defined by EN 61000-6-2 and EN 61000-6-4 standards. To meet these requirements, the following installation and operation considerations were taken into account:

- Shielding DVI/Analog RGB/USB cables

Although these considerations were deliberated during testing, actual EMC environments vary greatly. Therefore, these considerations may not be necessary. Likewise, additional measures, such as filtering, wire separation, and cable routing, may need to be considered to ensure intended operation of the overall system

9. Product Labels

9-1 TMG-310-DC00-01

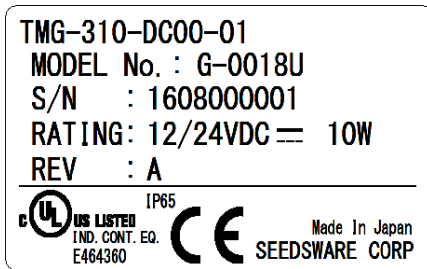

9-2 TMH-310-DC00-01

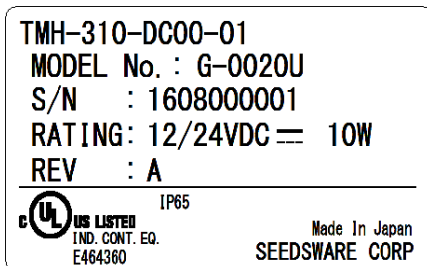

9-3 TMG-312-DC00-01

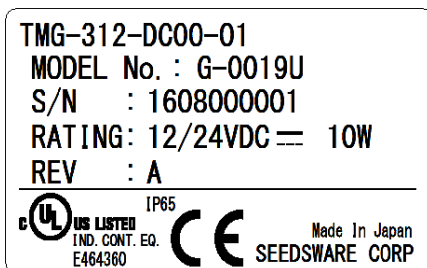

9-4 TMH-312-DC00-01

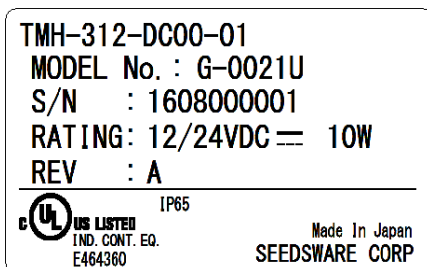

10. FCC Label

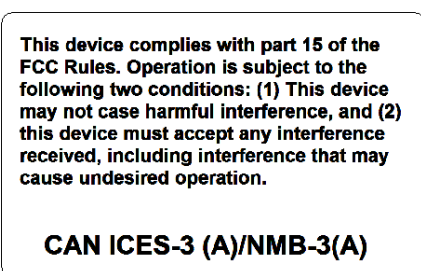

11. Warranty

11-1 Warranty Period

The warranty period is limited to 12 months (1 year) from the date of shipment. Warranty for any repair needed to the same repaired part of the same product is three months. Any defects that occur upon normal use under conditions specified herein will be repaired (factory repair) free of charge.

Any defected parts under proper use will be examined by the supplier and replaced by the new parts if the defect is considered to be caused by the supplier.

11-2 Warranty Exceptions

You will be liable for all repair fees even within the warranty period for any conditions listed below:

- (1) Any malfunctions, defects, and/or damages that occurred during transport, transfer, or mishandling by the user after delivery
- (2) Any malfunctions, defects, and/or damages caused by natural or man-made disaster.
- (3) Any malfunctions and damages caused by static electricity.
- (4) If the product is used under any condition, in any environment, or by any method other than those specified in the specifications, catalogs, manuals, notes, and/or other documents.
- (5) Any replacement of consumables.
- (6) Any malfunctions, defects, and/or damages caused by associated equipment and/or usage of inappropriate consumables and media.
- (7) If the product is repaired, remodeled, modified, or disassembled by a party other than Seedware
- (8) If the product cannot be identified by a serial number.
- (9) Any malfunctions, defects, and/or damages that are to have been caused on your behalf.

This warranty covers only the product itself. Any damages, on-site repairs and replacement driven by the failure of the product will be decided upon discussion by both parties as necessary.

This product is structurally not repairable. All damaged parts are subject for replacement and freight will be charged.

12. Production Discontinuance

In the event of production discontinuance, an announcement will be made on our website six months prior to the last possible order reception date.

13. Others

For comments or inquiries, feel free to contact us via e-mail or phone.

* Product, specification and/or anything noted are subject to change for improvement without prior notice.

By Phone

 **+1-630-832-0438 (Business Hours 9:00a.m.~5:45p.m.)**

By E-mail

 **sales@uscoamerica.com**

FAQ

 **www.seedsware.co.jp/global/support/faq/**

Microsoft®, Windows® 7, Windows® 8, and Microsoft® 10 are trademarks and registered trademarks of Microsoft Corporation USA in the United States and other countries. Other company and/or product names listed herein are also trademarks and/or registered trademarks.

3rd Edition September 2016

USCO America Inc.

136 W. Valletts Street, Elmhurst, IL 60126 USA

Phone: 630-832-0438/510-931-9046

E-mail: sales@uscoamerica.com

Business hours: 9:00a.m. ~5:45p.m. (Central Time)

<http://uscoamerica.com/>

This document is protected by copyright law. Photocopying, duplicating, reproducing, and modifying of this product or document in part or by whole is prohibited.

寸法許容差 呼び寸法 Nominal Dimensions	TOLERANCE
L ≤ 3	±0.4
3 < L ≤ 6	±0.48
6 < L ≤ 10	±0.58
10 < L ≤ 18	±0.7
18 < L ≤ 30	±0.84
30 < L ≤ 50	±1.0
50 < L ≤ 80	±1.2
80 < L ≤ 120	±1.4
120 < L ≤ 180	±1.6
180 < L ≤ 250	±1.85
250 < L ≤ 315	±2.1
315 < L ≤ 400	±2.3
400 < L ≤ 500	±2.5

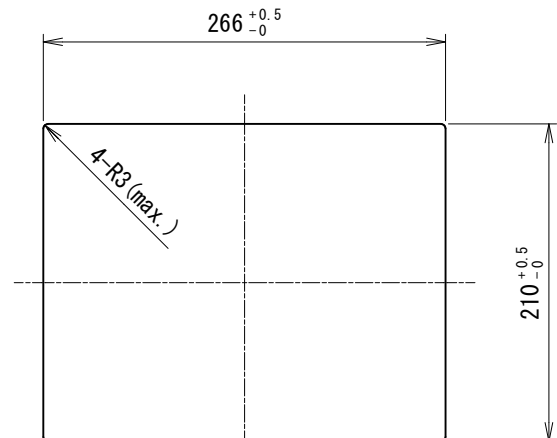
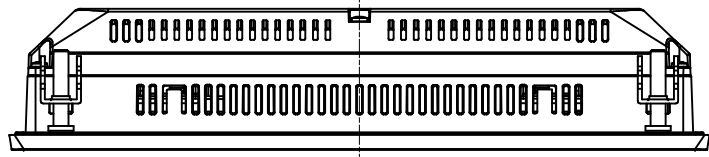

パネル開口寸法 (S=1:5)
Panel Cutout Dimensions (S=1:5)

SYM	改訂日 DATE	改訂内容 DESCRIPTION	ページ PAGE	担当 DESIGNED
	2016.05.18	新規図面登録 New Diagram Registration	-	S. Yoshimoto
△	2016.08.01	英語併記 English added	-	S. Yoshimoto
△	2016.08.17	FGマーク追加 FG mark added	-	S. Yoshimoto
△	2016.09.01	FCCラベル追加 FCC Label added	-	S. Yoshimoto

NOTES

- 誤動作の恐れがある為、パネル開口寸法をお守り下さい。
又、取付けパネルには、反り、傷、凹凸のないものを使用して下さい。
To prevent malfunctions, panel opening dimension shall strictly be as specified.
Be sure to use installation panels without warpage, scratches, and dents.

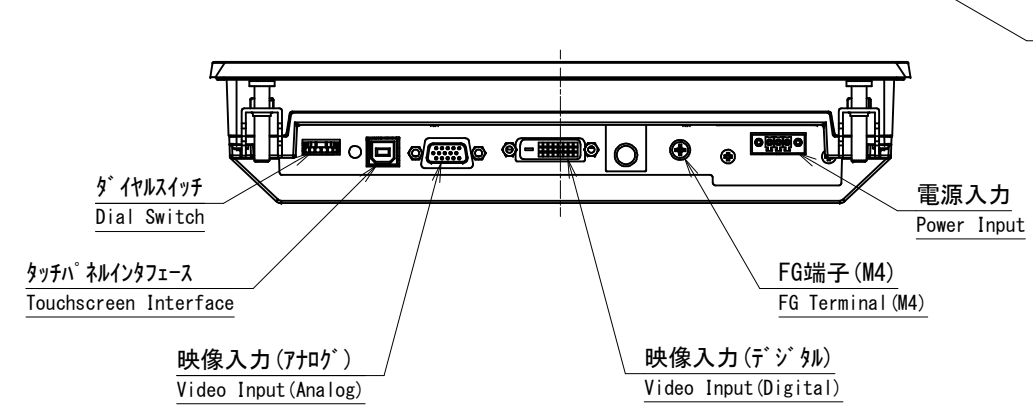
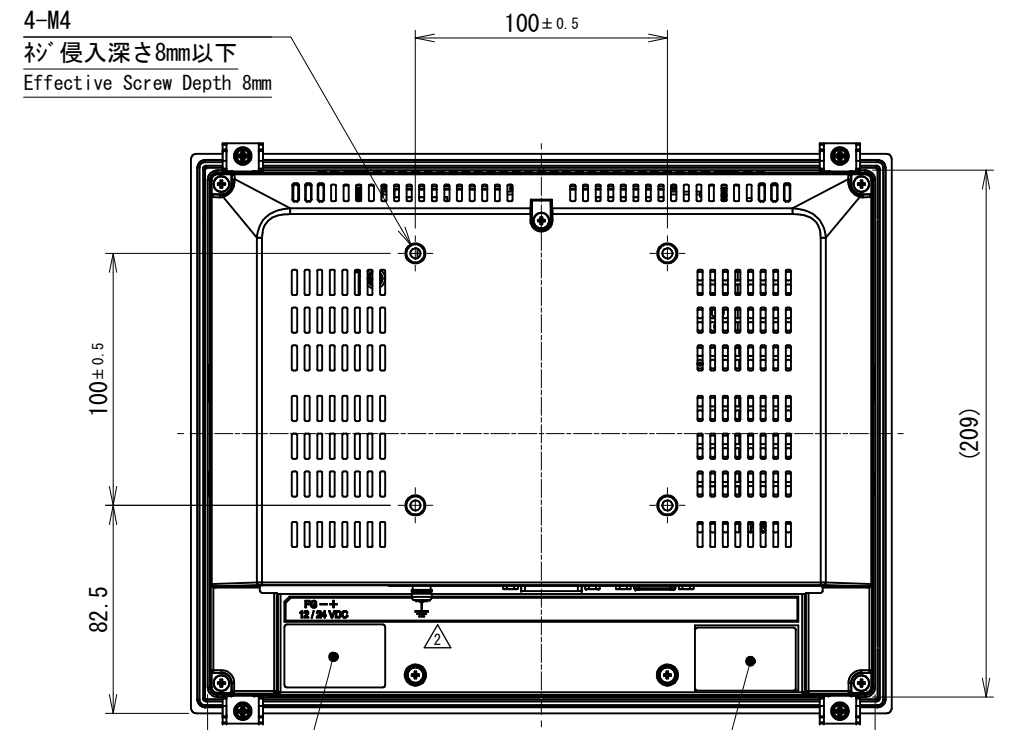
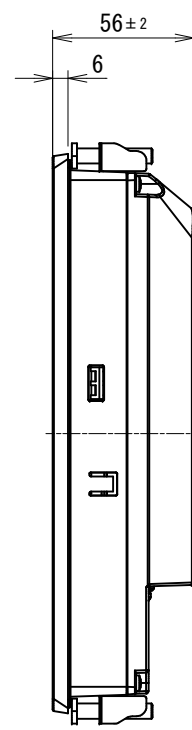
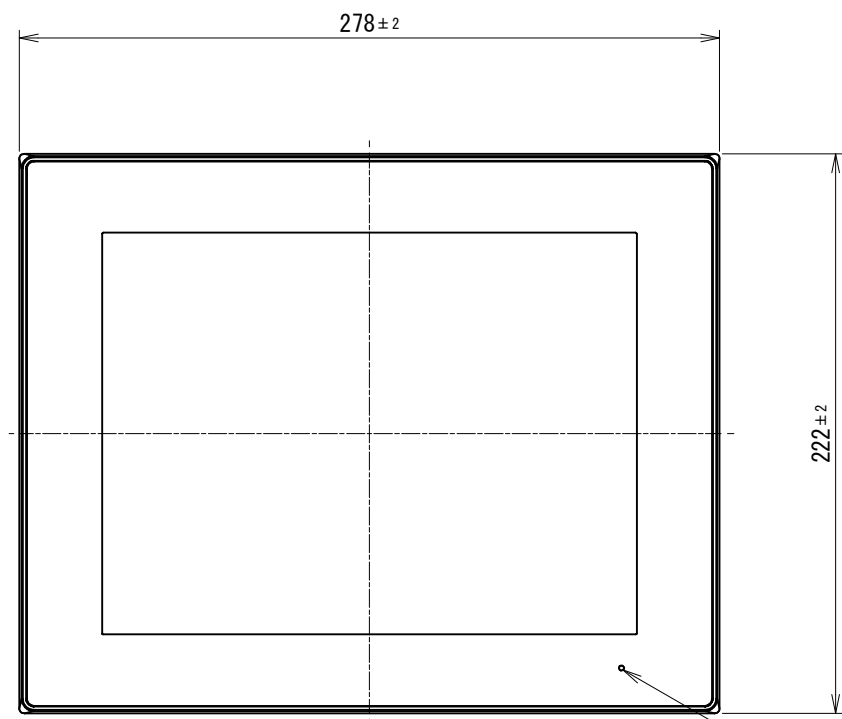

状態表示LED
Status Display LED

ダイヤルスイッチ
Dial Switch

電源入力
Power Input

タッチパネルインタフェース
Touchscreen Interface

映像入力 (アナログ)
Video Input (Analog)

映像入力 (デジタル)
Video Input (Digital)

FG端子 (M4)
FG Terminal (M4)

NOTES

- 指示なき寸法公差は一般寸法公差とする。
Tolerance shall be of general dimensional tolerance unless specified otherwise.
- 製品型式
投影型静電容量方式タッチパネルモデル : TMG-310-DC00-01
アナログ抵抗膜方式タッチパネルモデル : TMH-310-DC00-01
Product Model
Projected Capacitive Touchscreen Model : TMG-310-DC00-01
Analog resistive Touchscreen Model : TMH-310-DC00-01

製図日 ISSUED	2016.09.01	部署 SECTION	Technical Dept.	尺度 SCALE	CAD登録名 CAD FILE NAME	12K012-2_TM-10_OUTLINE	RoHS対応品 RoHS compliant
承認 APPROVED		検図 CHECKED		1:3	製品名 MODEL	10.1" LCD Touchscreen Monitor	
		製図 DRAWN	S. Yoshimoto	単位 UNIT	図名 TITLE	OUTLINE	ページ PAGE
		設計 DESIGNED	S. Yoshimoto	mm			1 / 1
H. Tsuji			T. Okada	図番 DWG No.		SM3-001881-13	
 株式会社 シーズウェア				A3			

寸法許容差	TOLERANCE
呼び寸法	Nominal Dimensions
$L \leq 3$	± 0.4
$3 < L \leq 6$	± 0.48
$6 < L \leq 10$	± 0.58
$10 < L \leq 18$	± 0.7
$18 < L \leq 30$	± 0.84
$30 < L \leq 50$	± 1.0
$50 < L \leq 80$	± 1.2
$80 < L \leq 120$	± 1.4
$120 < L \leq 180$	± 1.6
$180 < L \leq 250$	± 1.85
$250 < L \leq 315$	± 2.1
$315 < L \leq 400$	± 2.3
$400 < L \leq 500$	± 2.5

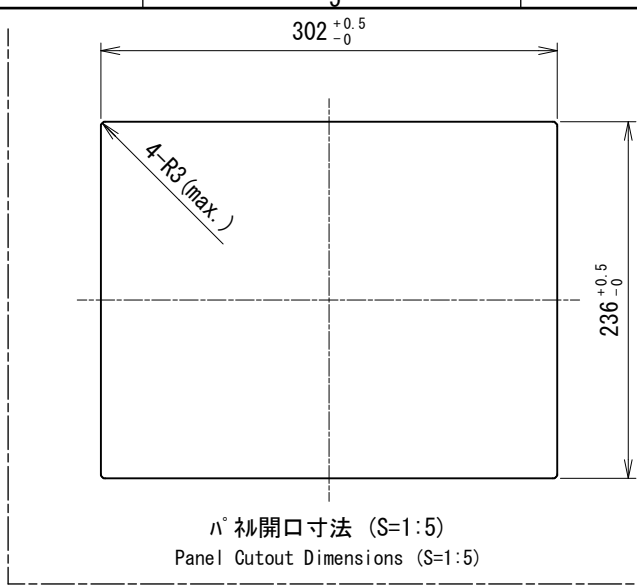
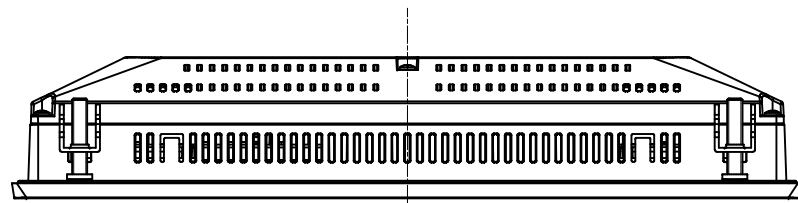

SYM	改訂日 DATE	改訂内容 DESCRIPTION	ページ PAGE	担当 DESIGNED
	2016.05.18	新規図面登録 New Diagram Registration	-	S. Yoshimoto
△	2016.08.01	英語併記 English added	-	S. Yoshimoto
△	2016.08.17	FGマーク追加 FG mark added	-	S. Yoshimoto
△	2016.09.01	FCCラベル追加 FCC Label added	-	S. Yoshimoto

NOTES
 1. 誤動作の恐れがある為、パネル開口寸法をお守り下さい。
 又、取付けパネルには、反り、傷、凹凸のないものを使用して下さい。
 To prevent malfunctions, panel opening dimension shall strictly be as specified.
 Be sure to use installation panels without warpage, scratches, and dents.

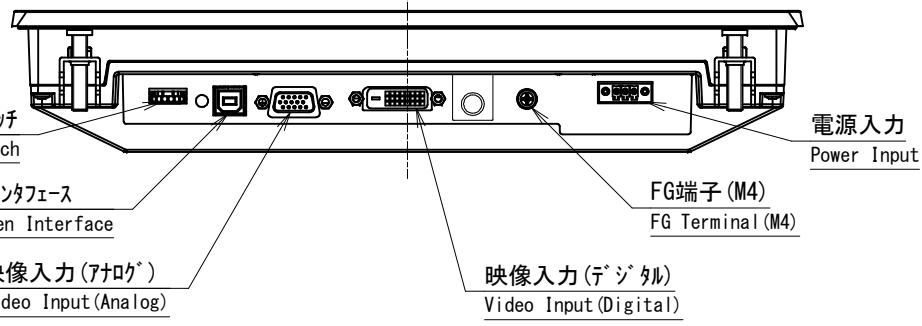
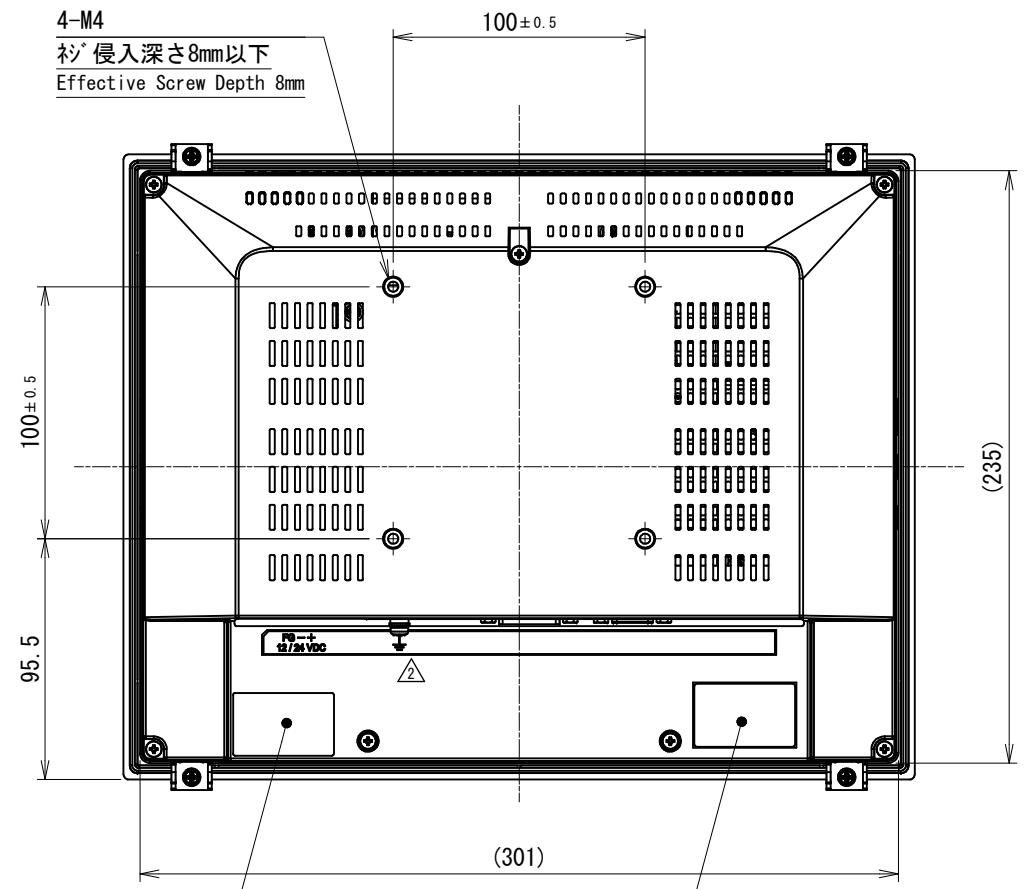
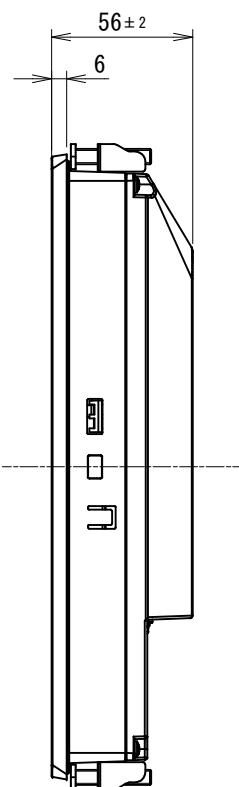
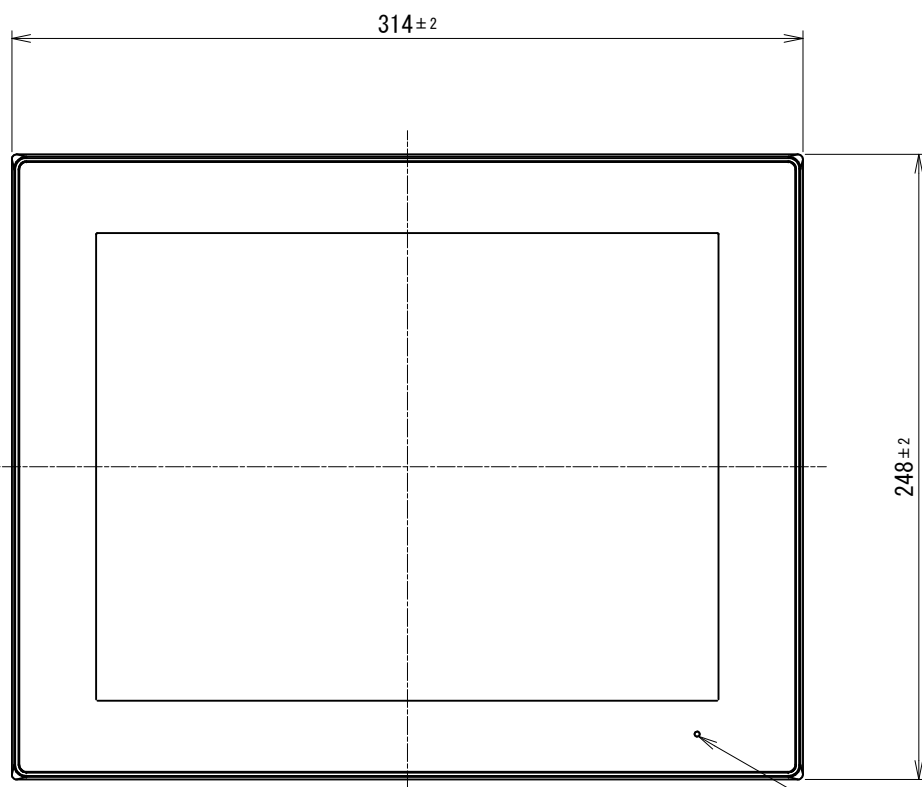

NOTES
 1. 指示なき寸法公差は一般寸法公差とする。
 Tolerance shall be of general dimensional tolerance unless specified otherwise.
 2. 製品型式
 投影型静電容量方式タッチパネルモデル : TMG-312-DC00-01
 アナログ抵抗膜方式タッチパネルモデル : TMH-312-DC00-01
 Product Model
 Projected Capacitive Touchscreen Model : TMG-312-DC00-01
 Analog resistive Touchscreen Model : TMH-312-DC00-01

製図日 ISSUED	2016.09.01	部署 SECTION	Technical Dept.	尺度 SCALE	CAD登録名 CAD FILE NAME	12K001-2_TM-12_OUTLINE	RoHS対応品 RoHS compliant
承認 APPROVED		検図 CHECKED		1:3	製品名 MODEL	12.1" LCD Touchscreen Monitor	
		製図 DRAWN		単位 UNIT	図名 TITLE	OUTLINE	ページ PAGE
H. Tsuji	T. Okada	S. Yoshimoto	S. Yoshimoto	mm			1 / 1
 株式会社 シーズウェア			A3	図番 DWG No.	SM3-001882-13		